

# Optical Connector Cleaner NEOCLEAN-EZ3 User's Manual

Thank you for choosing the "NEOCLEAN-EZ3" optical connector cleaner. This product is a "pen-shaped" optical connector cleaner that enables you to clean optical connector ferrule end face with a simple, one-push action. Please read this manual carefully to ensure proper use of this equipment.

 <b>Caution!</b>	<ul style="list-style-type: none"> <li>• This product is intended for use as a cleaner for optical connector ferrule end face. Do not use for any other purposes.</li> <li>• Do not use this product for cleaning lens type optical ports (such as transceivers, reception ports for optical measurement equipment, etc.).</li> <li>• Do NOT disassemble this product.</li> <li>• Do NOT touch the cleaning thread.</li> <li>• Please consign this product to a properly licensed waste management operator.</li> </ul>
--	---

## 1. Names and Descriptions of Parts

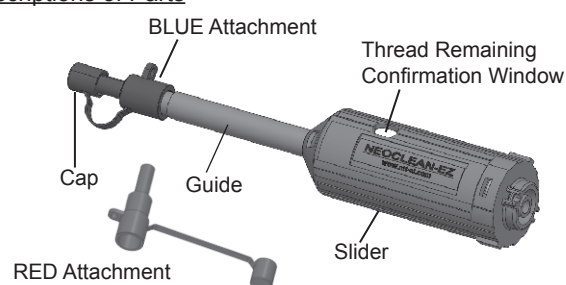

- **Thread Remaining Confirmation Method**  
When the thread has run out, a blue colored tape appears in the Thread Remaining Confirmation Window. One cleaner can be used for approximately 400 times.
- **Storage**  
Avoid storing in locations with high temperature and humidity.

## 2. Compatible Connectors

Product Name (Model No.)	Connector	Attachment Color
NEOCLEAN-EZ3[ATC-NE-EZ3]	SC, FC, ST, E2000	BLUE
	SMPTE 304M connector	RED

## 3. Method of Use

### ● Cleaning Optical Connector Ferrule End Face Inside an Adaptor

- ① Remove the attachment and insert the guide straight into the adaptor.

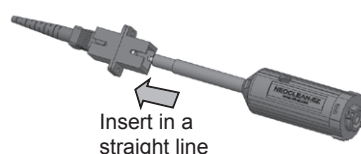

- ② Push in the slider. The cleaning is completed when the push action stops.

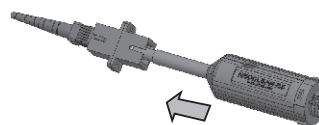

### ● Cleaning an Optical Connector Plug

- ① Remove the cap.

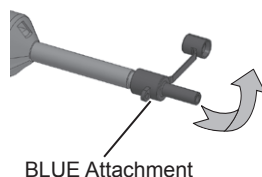

- ② Insert the plug into the hole of the tip on the front end.

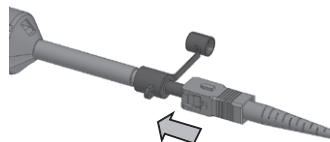

- ③ Push in the slider. The cleaning is completed when the push action stops.

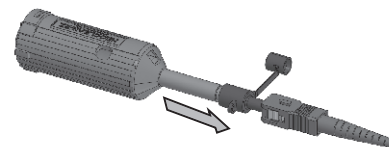

## 4. How to clean 2.0mm based SMPTE 304M connector

### ◆ Socket

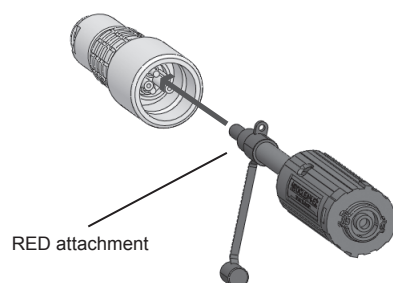

### ◆ Plug

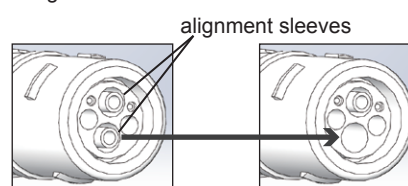

You may refer to the LEMO's Fibre Optic Contact Cleaning Guide. (<https://www.youtube.com/watch?v=s9nYt3gsXK8>)

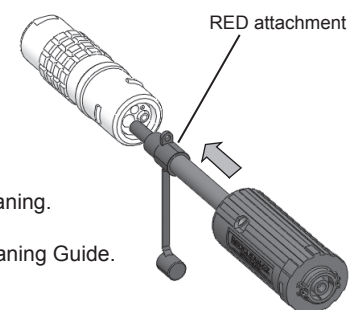

\* NEOCLEAN is a trademark of NTT Advanced Technology Corporation.

### ● Inquiries

NTT Advanced Technology Corporation  
[http://www.ntt-at.com/product/optical\\_cleaner/](http://www.ntt-at.com/product/optical_cleaner/)

